

N O R
F A X

Brukervennlige og bærekraftige
løsninger til nordiske uterom

Montasjen er laget i samarbeid
med produsent

post@norfax.no
66 80 00 60

norfax.no

Montasjeanvisning

Tremiljø 3 felter



Det trengs følgende deler for å montere side- og bakvegger:



Art.nummer:
1130030
Brakett U-
For feste av bakvegger- se punkt 5.



Art.nummer:
Arbeidsskrue
For å skru fast Brakett U til bakvegg
- se punkt 5.



Art.nummer:
Tannmutter-
Feste punkt for sidevegger i Side stolpe



Art.nummer:
1130031
Brakett vinkel-
For feste av sidevegger- se punkt 9.



Art.nummer:
Franskskrue
For å skru fast Brakett U til bakvegg i treverk
- se punkt 5.



Art.nummer:
Umbraco skru
For feste av sidevegger inn i stolpe og via Tannmutteren punkt 9.

1. Legg stolpene horisontalt på to bukker el. lignende i denne rekkefølgen.
(se siste side for «Oversiktstegning»)

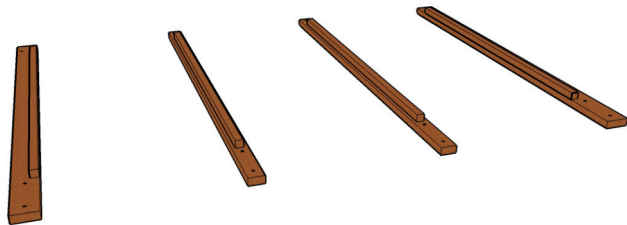

2. Plasser øvre og nedre drager, samt festesko.

NB!
Hvis leskuret monteres på eksisterende fundament bør føttene vris 180 grader for å ha nok av stand til eksisterende hullbilde. Se illustrasjon på side -.

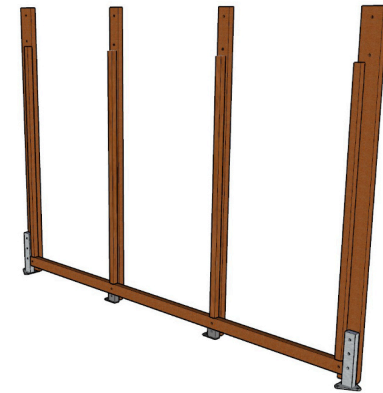
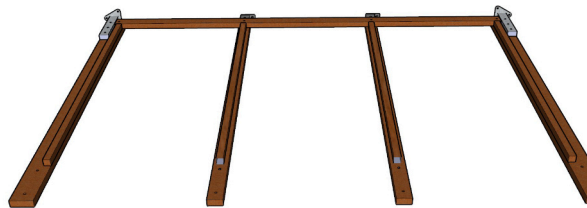

3. Legg på stolper og stram til med bolter.
Sett fast benkeknektene.

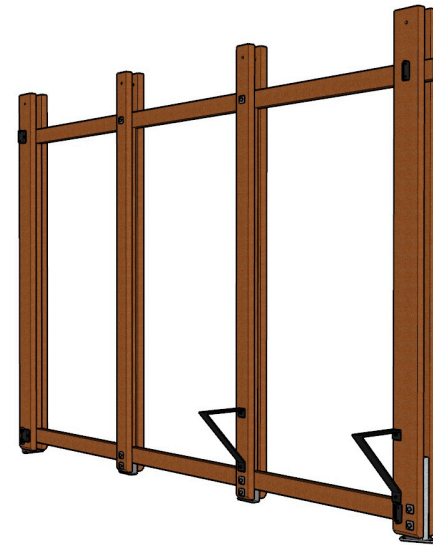
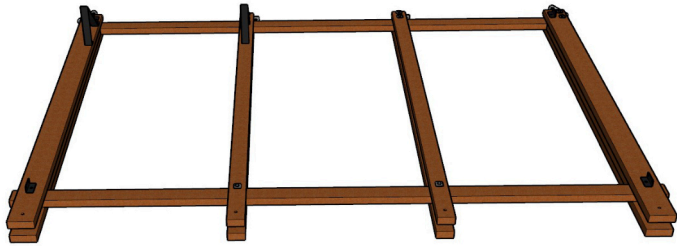

4. Legg veggfeltene ned i U-braketter som er festet i dragerne.

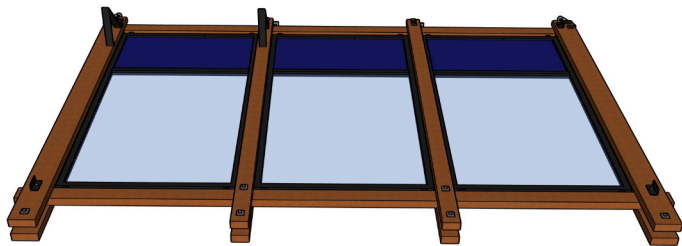

5. Snu U-brakettene og stram til skruene, for å sikre veggfestene

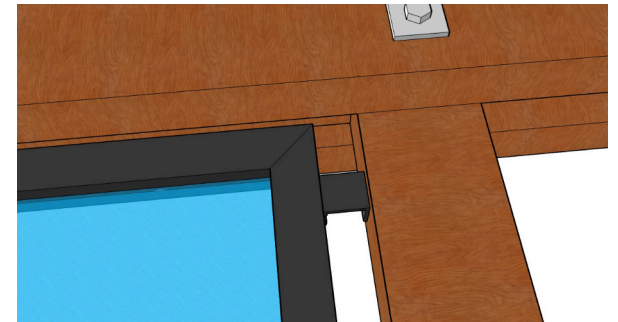
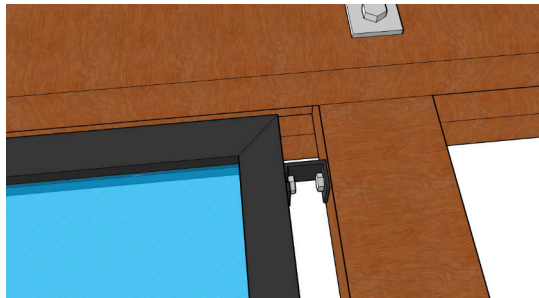

6. Fest gavlfeltene på hjørnestolpene

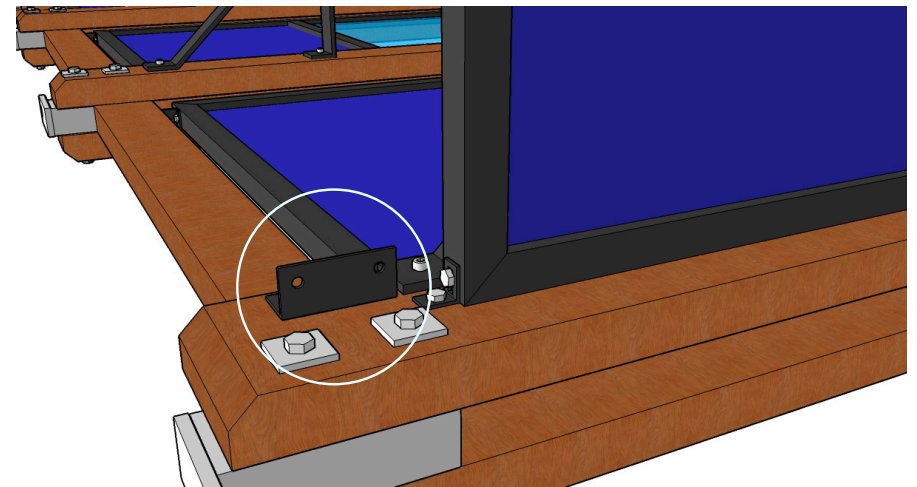
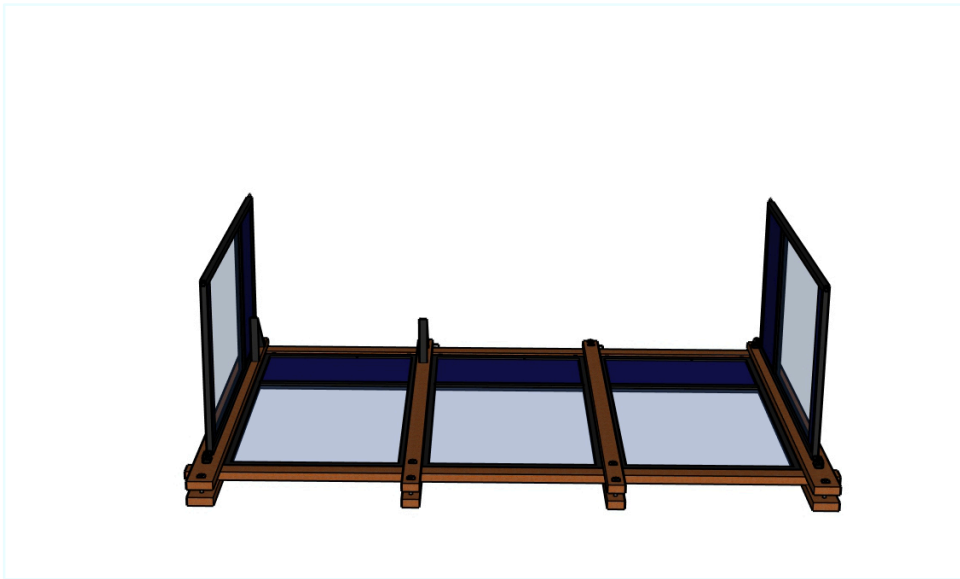

7. Reis opp veggene på løse klosser plassert under gavelfeltene

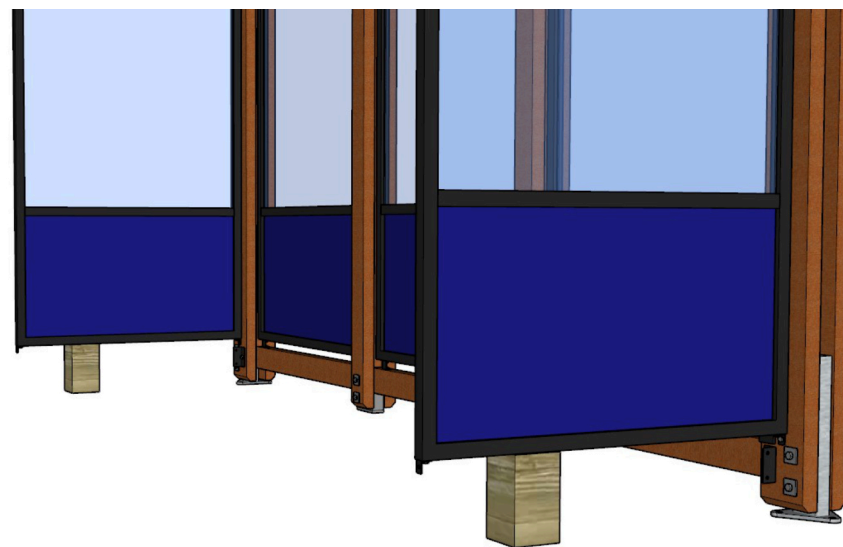

8. Sett sammen endestolper og øvre drager (front) på samme måte som vist i punkt 1 - 3



9. Fest endestolpene til gavlveggene og skru fast dekkbord over og under

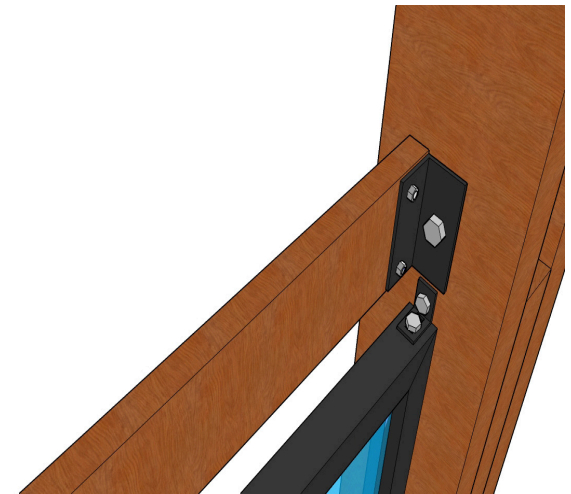
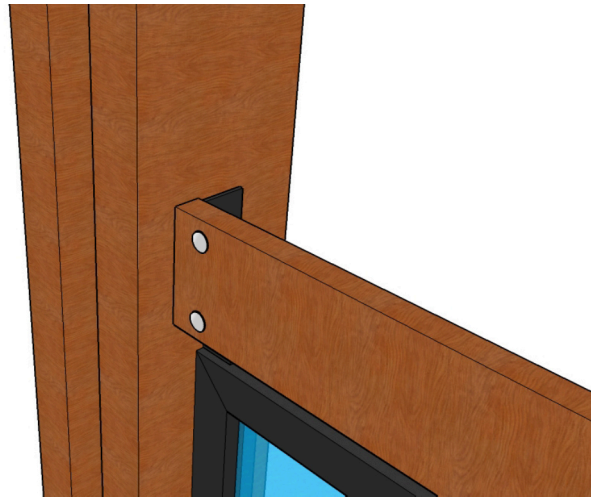

10. Løft på taket og fest med bolter

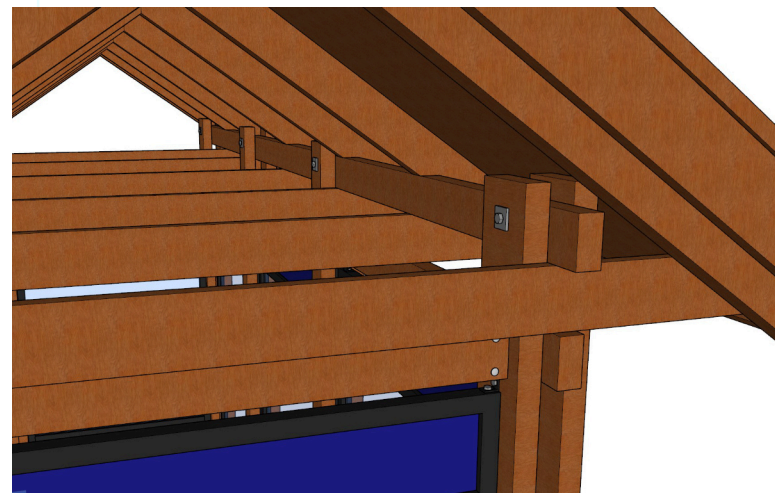

11. Skru fast benke plankene

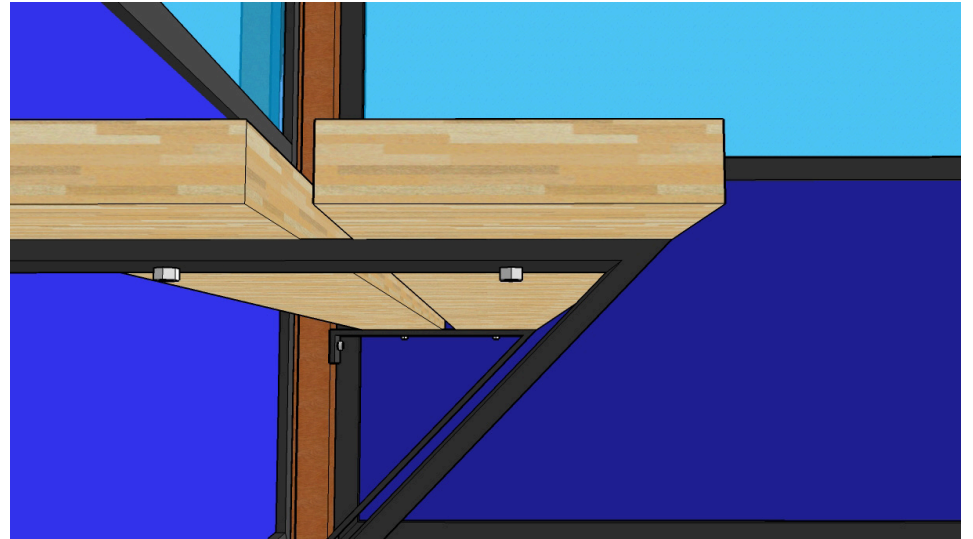
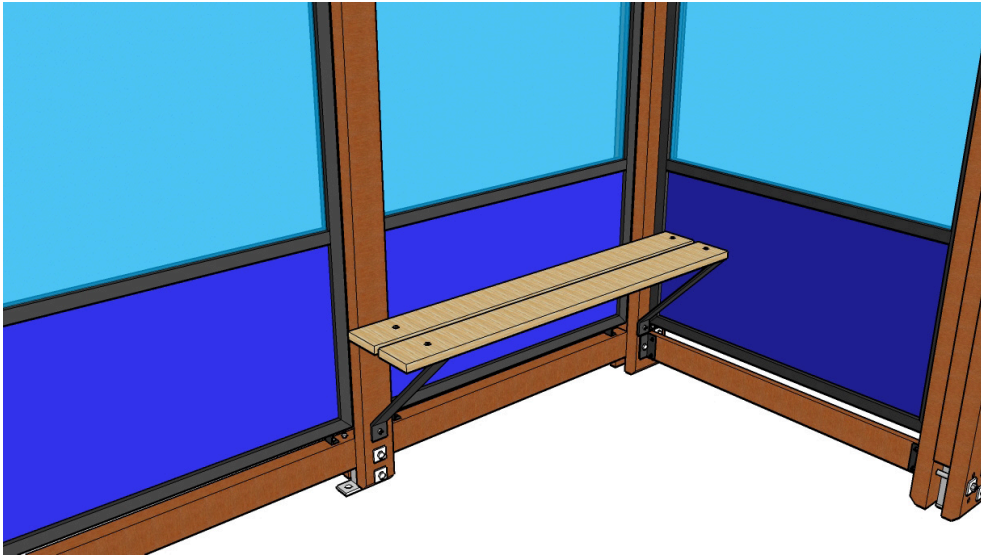

Gratulerer ! Du har nå montert et Tremiljø leskur



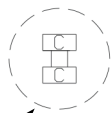

Denne stolpen gjelder kun ved
option for frontvegg

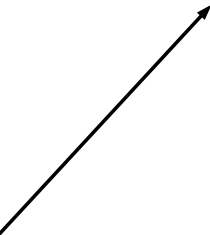

Inngang

Montering på eksisterende
«Tremiljø» fundament.

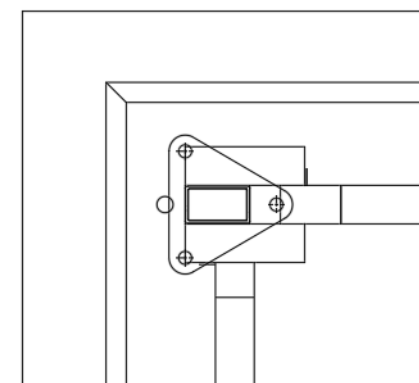
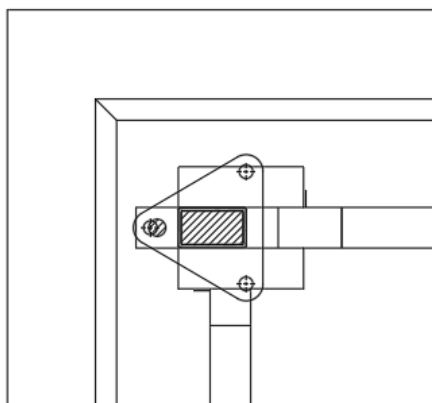
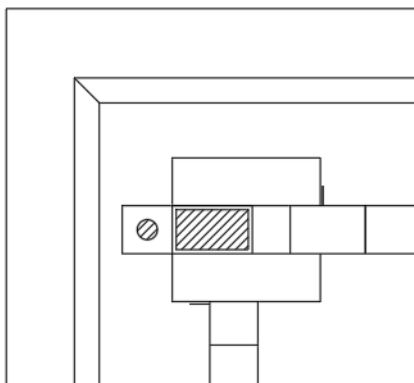

Ved montering på eksisterende fundament bør triangel foten roteres 180 grader.
Som illustrasjon viser over, vil det oppstå et avvik på ca 8 mm om man prøver å ha
Triangelfoten på standard måte.