

N O R
F A X

Brukervennlige og bærekraftige
løsninger til nordiske uterom

Montasjen er laget i samarbeid
med produsent

post@norfax.no
66 80 00 60

norfax.no

Montasjeanvisning

Tremiljø 2- felter



Det trengs følgende deler for å montere side- og bakvegger:



Art.nummer:

1130030

Brakett U-

For feste av bakvegger- se punkt 5.



Art.nummer:

Arbeidsskrue

For å skru fast Brakett U til bakvegg

- se punkt 5.



Art.nummer:

Tannmutter-

Feste punkt for sidevegger i Side stolpe



Art.nummer:

1130031

Brakett vinkel-

For feste av sidevegger- se punkt 9.



Art.nummer:

Franskskrue

For å skru fast Brakett U til bakvegg i treverk

- se punkt 5.

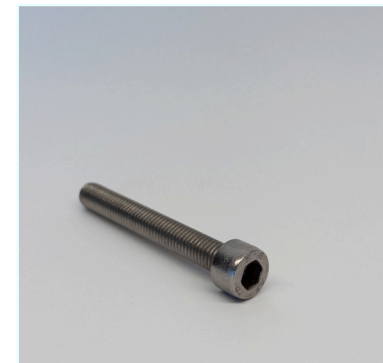

Art.nummer:

Umbraco skru

For feste av sidevegger inn i stolpe og via Tannmutteren punkt 9.

1. Legg stolpene horisontalt på to bukker el. lignende i denne rekkefølgen.
(se siste side for «Oversiktstegning»)

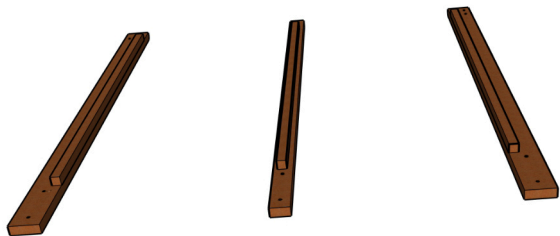

2. Plasser øvre og nedre drager, samt festesko.

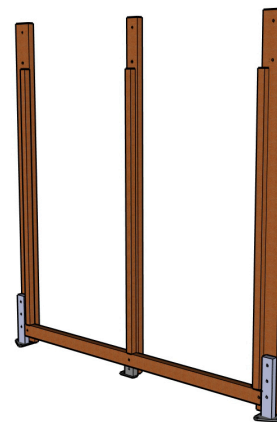
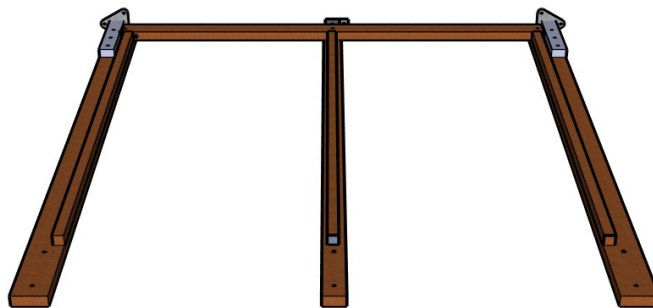

3. Legg på stolper og stram til med bolter.
Sett fast benkeknektene.

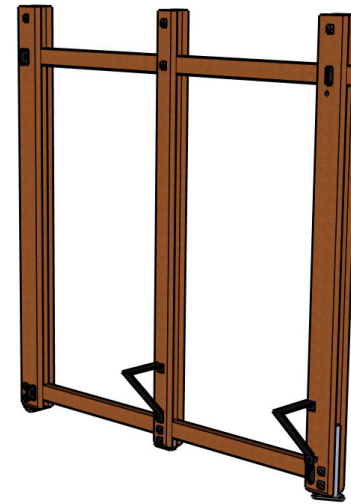
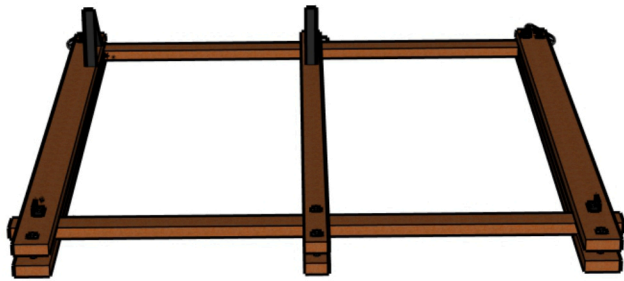

4. Legg veggfeltene ned i U-braketter som er festet i dragerne.

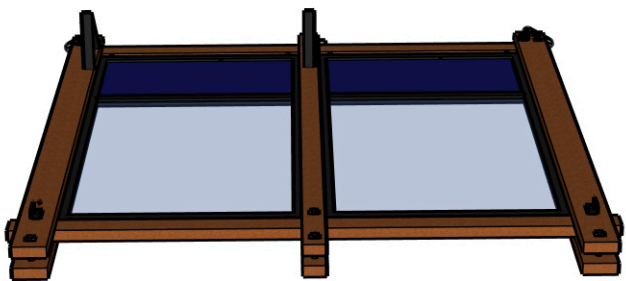

5. Snu U-brakettene og stram til skruene, for å sikre veggfestene

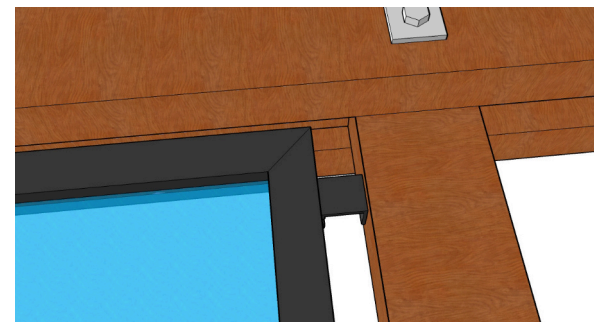
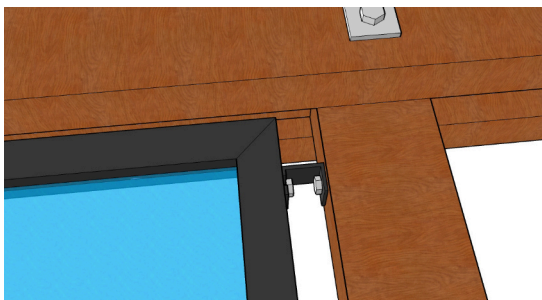

6. Fest gavlfeltene på hjørnestolpene

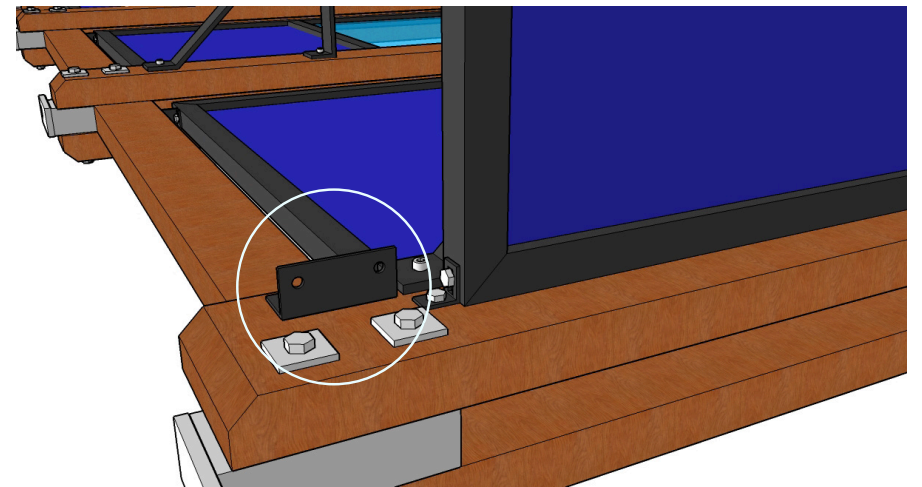
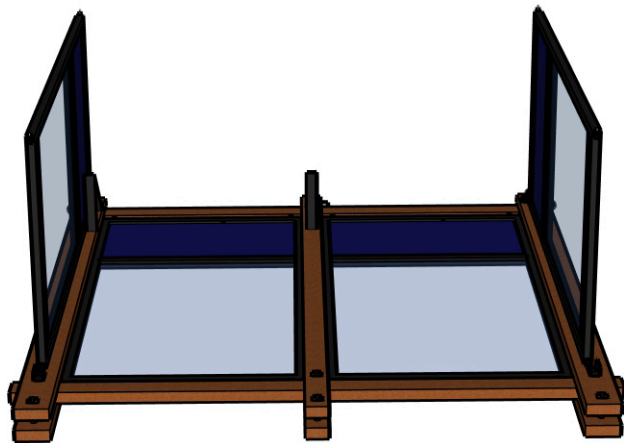

7. Reis opp veggene på løse klosser plassert under gavelfeltene

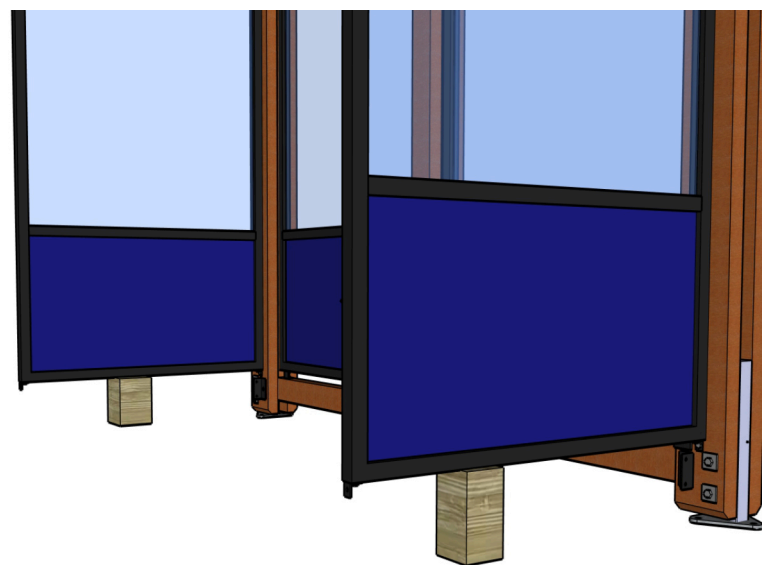

8. Sett sammen endestolper og øvre drager (front) på samme måte som vist i punkt 1 - 3



9. Fest endestolpene til gavlveggene og skru fast dekkbord over og under

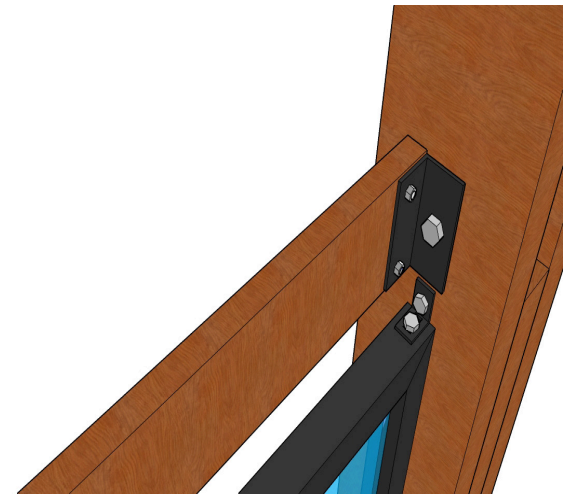
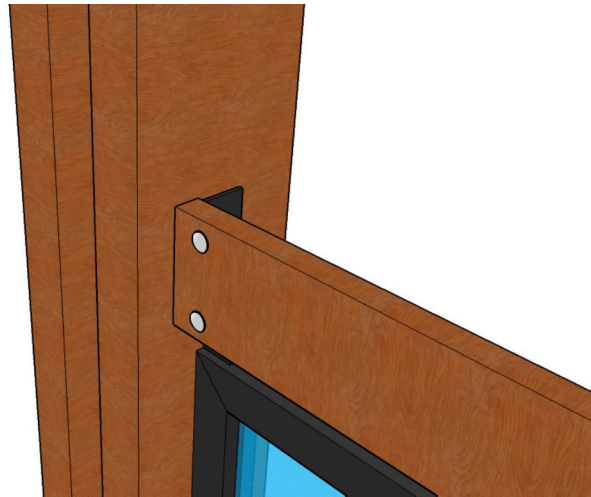

10. Løft på taket og fest med bolter

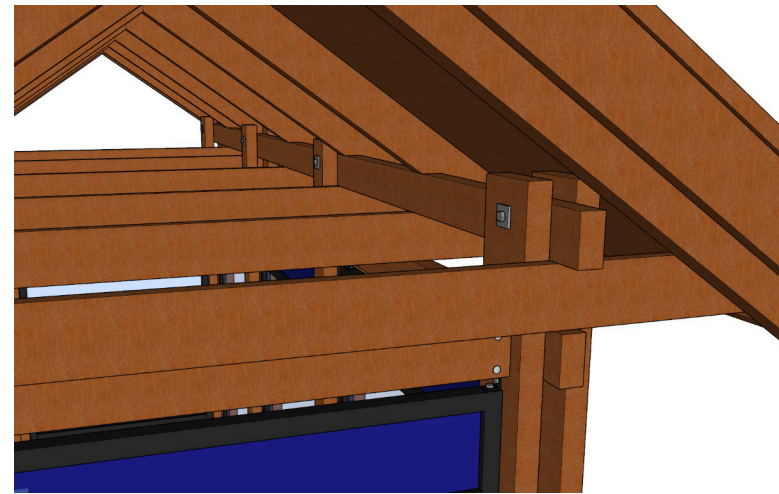

11. Skru fast benke plankene

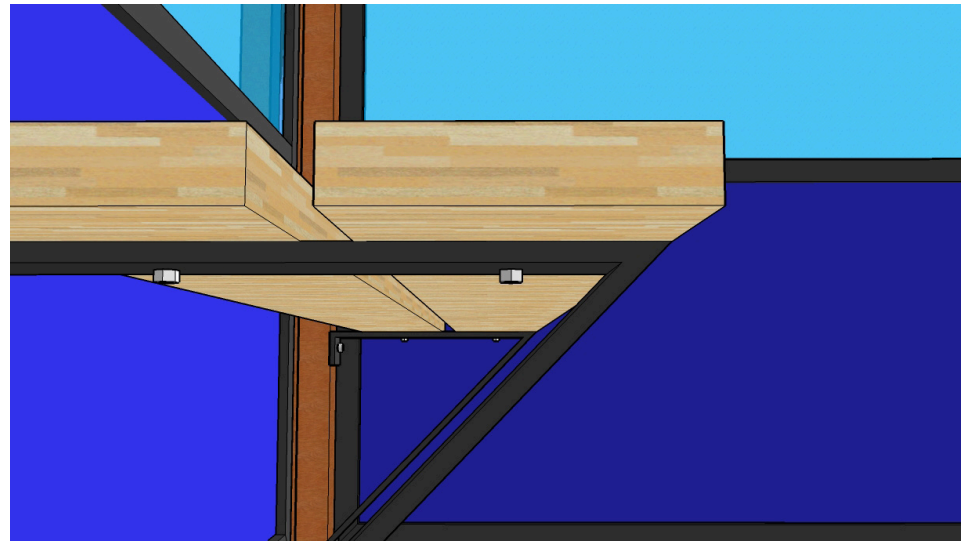
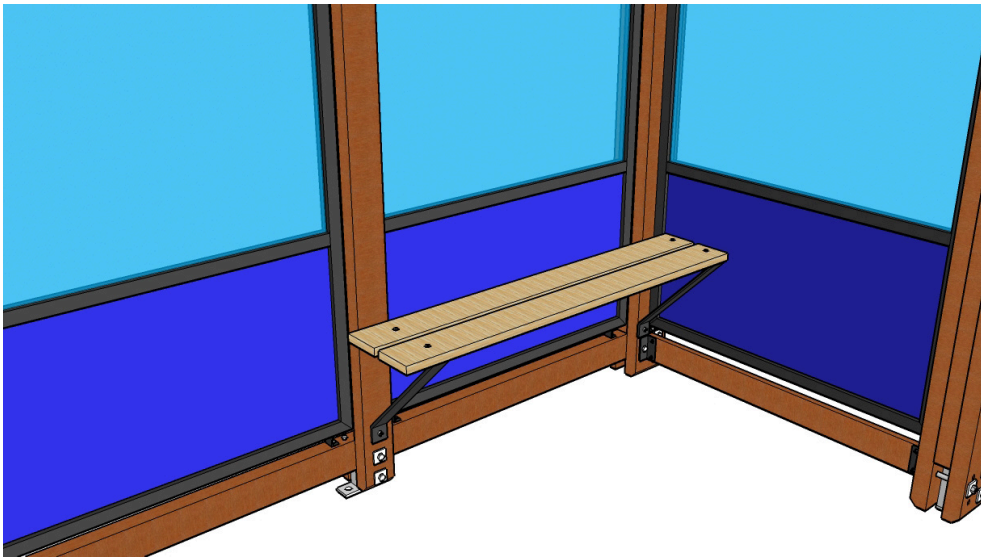

Gratulerer ! Du har nå montert et Tremiljø leskur



Oversiktstegning

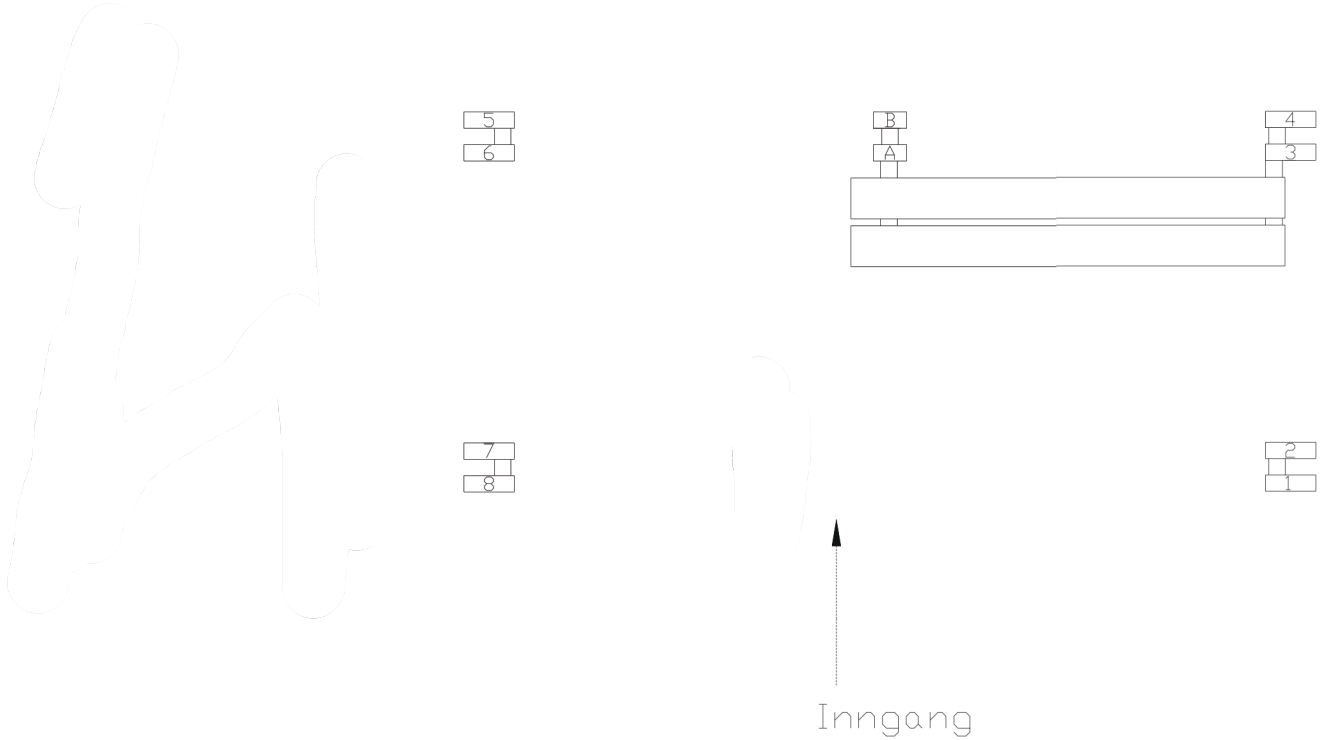

Montering på eksisterende
«Tremiljø» fundament.

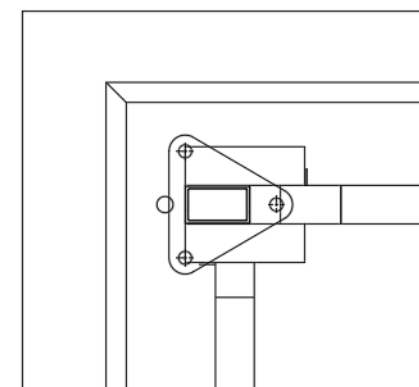
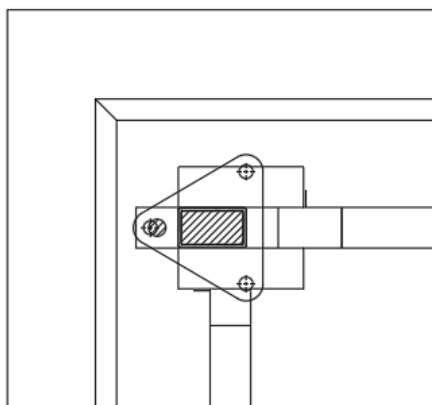
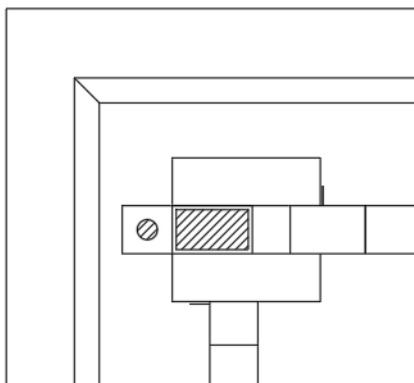

Ved montering på eksisterende fundament bør triangel foten roteres 180 grader.
Som illustrasjon viser over, vil det oppstå et avvik på ca 8 mm om man prøver å ha
Triangelfoten på standard måte.